

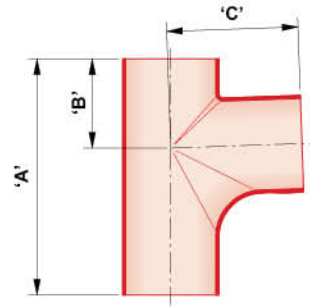

Branches - Single Equal & Unequal

88° Single Branch - Radius Curve

Product code	Typical dimension			
	Nominal Diameter (mm)	Dim. (mm) 'A'	Dim. (mm) 'B'	Dim. (mm) 'C'
C8341.03171	70X70	210	80	130
C8341.03174	100X70	221	90	142
C8341.03176	100X100	270	102	150
C8341.03178	150X100	300	117	202
C8341.03180	150X150	400	140	260
C8341.03182	200X150	428	157	283
C8341.03184	200x200	478	182	293



88° Single Branch with Access - Radius Curve

Product code	Typical dimension			
	Nominal Diameter (mm)	Dim. (mm) 'A'	Dim. (mm) 'B'	Dim. (mm) 'C'
C8343.03240	100X100	270	102	150
C8343.03243	150X100	300	117	202
C8343.03245	150X150	400	140	260

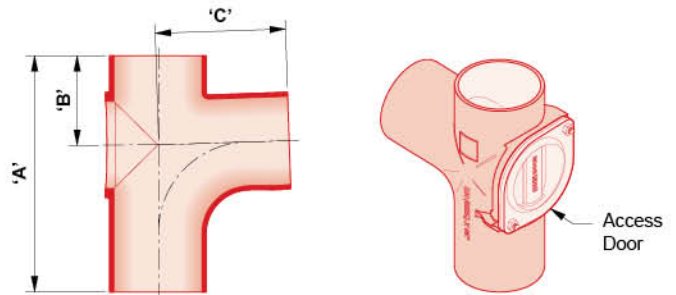

Branches - Double Branch

45° Double Branch

Product code	Typical dimension			
	Nominal Diameter (mm)	Dim. (mm) 'A'	Dim. (mm) 'B'	Dim. (mm) 'C'
C8342.03009	100X100	295	240	240
C8342.03017	150X100	355	265	265
C8342.03018	150X150	455	340	340

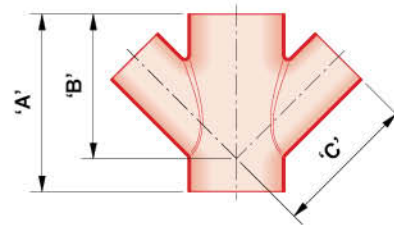

88° Double Branch - Radius Curve

Product code	Typical dimension			
	Nominal Diameter (mm)	Dim. (mm) 'A'	Dim. (mm) 'B'	Dim. (mm) 'C'
C8342.03268	100x100	270	102	150
C8342.03269	150x100	300	117	202
C8342.04120	200x150	428	157	283

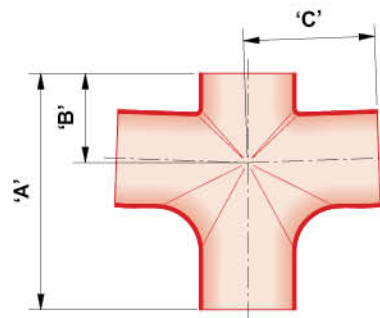



Branches - 4 Way Junctions

Product code	Typical dimension			
	Nominal Diameter (mm)	Dim. (mm) 'A'	Dim. (mm) 'B'	Dim. (mm) 'C'
C83421.100	100X100	230	230	200
C83421.150	150X100	270	270	200

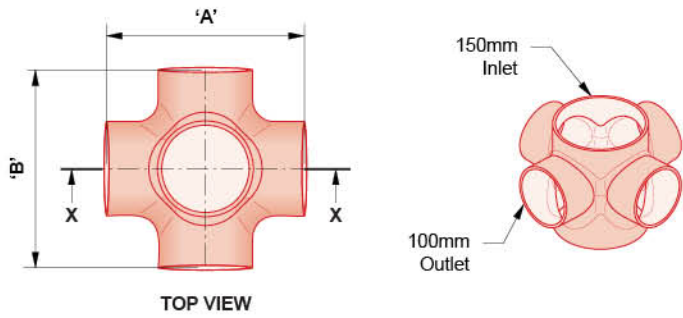

TOP VIEW

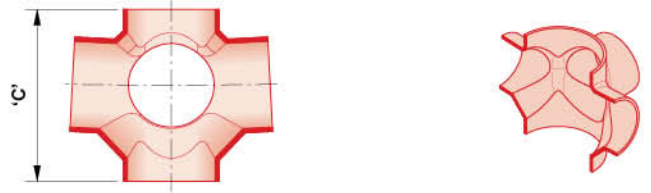

SECTION VIEW X-X

Traps - P-Trap

Product code	Typical dimension		
	Nominal Diameter (mm)	Dim. (mm) 'A'	Dim. (mm) 'B'
C864.03127	70	200	138
C864.03119	100	285	165
C864.03219	150	350	240

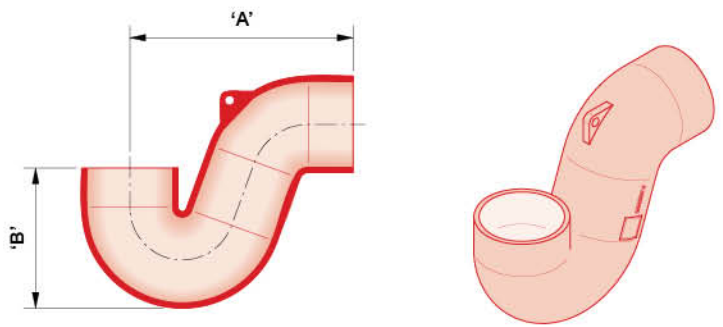

Traps - Floor Trap

Product code	Typical dimension			
	Dim. (mm) 'A'	Dim. (mm) 'B'	Dim. (mm) 'C'	Dim. (mm) 'D'
C864.100703	260	192	206	176

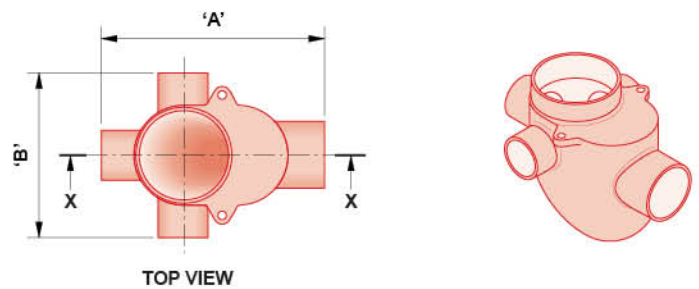

TOP VIEW

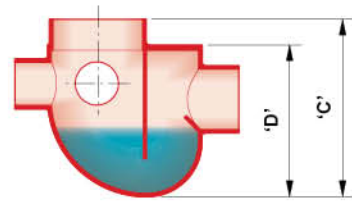

SECTION VIEW X-X